

JUSHA 5MP Medical Display

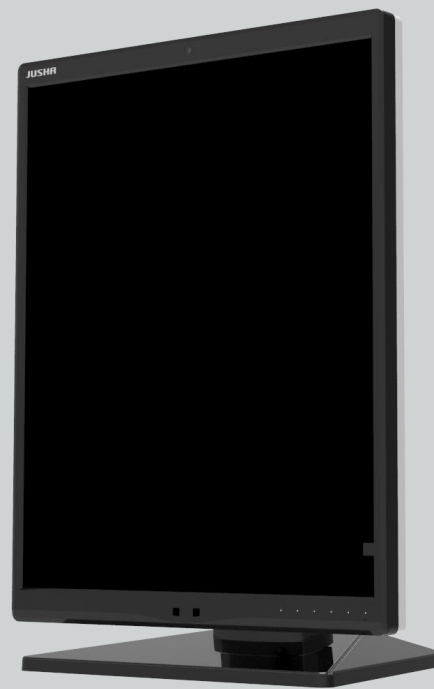

**M550 M550G
JUSHA-M550
JUSHA-M550G**

User Manual

Document No. : JSWI-03-187

Nanjing Jusha Display Technology Co., Ltd.

8A, Block 1, Nanjing International Service Outsourcing Mansion, No.301
Hanzhongmen Street, Nanjing City, Jiangsu Province, 210036 China

Tel: 0086-25-83305050

Fax: 0086-25-58783273

Free Hotline: 400-820-0556 800-820-0556

Visit us at the website: en.jusha.com.cn

Contents

1.	Manual instructions.....	1
1.1	About this manual.....	1
1.2	Explanation of symbols.....	1
1.3	Safety information.....	3
2.	Overview.....	6
2.1	Features.....	6
2.2	Packing list.....	8
2.3	Front view and keypad.....	9
2.4	Rear view and connection panel.....	11
3.	Display installation.....	12
3.1	Graphic card installation.....	12
3.2	Connecting the cables.....	13
3.3	Adjusting the screen position.....	14
3.3.1	Adjusting screen height.....	14
3.3.2	Adjusting the tilt and swivel angle.....	14
3.3.3	Rotating screen.....	15
3.4	Installing the display to wall or suspended arm.....	16
3.5	Multi-display configuration.....	17
3.5.1	For Microsoft Windows XP operation system.....	17
3.5.2	For Microsoft Windows 7 operation system.....	18
4.	Display settings.....	19
4.1	First time starting up.....	19
4.2	Sleeping.....	19
4.3	OSD overview.....	20
4.4	OSD operation.....	22
4.4.1	Open OSD.....	22
4.4.2	Exit OSD.....	22
4.4.3	Change Backlight.....	22
4.4.4	Change Curve.....	23
4.4.5	Reading Room.....	23
4.4.6	Ambient Brightness Adaptation.....	24
4.4.7	Change Input Source.....	24
4.4.8	Spotlight Type.....	25
4.4.9	Spotlight Size.....	25
4.4.10	Presence Induction.....	25
4.4.11	Key Music.....	26
4.4.12	OSD Language.....	26
4.4.13	Factory Reset.....	27
4.4.14	Display Status.....	27
4.5	Feature function setting.....	27
4.5.1	SmarTouch.....	28
4.5.2	X-ray film viewing.....	28
4.5.3	Spotlight.....	28
5.	Important information.....	30
5.1	Technical specifications.....	30
5.2	Environmental information.....	30
5.3	Safety standard.....	31
5.4	Electromagnetic compatibility.....	31
5.4.1	EMC information.....	31
5.4.2	EMI information.....	34
6.	Maintenance.....	35
7.	Cleaning and Disinfection.....	37

Contents

7.1	Cleaning.....	37
7.2	Disinfection.....	37
8.	Malfunction analysis.....	38
9.	Declarations.....	39
9.1	Legal notice.....	39
9.2	After sale service declaration.....	41
9.3	Proprietary rights.....	42
10.	Contact information.....	43





1. Manual instructions









1.1 About this manual

- This manual aims to guide users to install, configure and operate this professional medical display properly.
- When transfer the display to a third-party, please deliver this manual along with the display.
- Our goal is to provide you with the most accurate and usable documentation as soon as possible. If you discover any errors, please call us, or email.
- For any further questions about this manual, you are welcome to contact Nanjing Jusha Display Technology Co., Ltd. (hereinafter referred to as JUSHA).

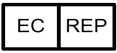
1.2 Explanation of symbols

This manual and product may use the symbols below.

	Note Gives extra information about the described subject.
	Warning Indicates general cautionary, warning, or danger level information.
	Electrical Shock Caution Indicates possibility of electric shock.
	Prohibition Indicates a general prohibition.
	*China Compulsory Certification (CCC) Indicates the product meets the requirements of CCC.

	<p>*Federal Communications Commission (FCC) Indicates the product meets the requirements of FCC.</p>
	<p>*Conformite European Certification (CE) Indicates the product meets the requirements of CE Certification.</p>
	<p>European Authorized Representatives Gives information of the Authorized European representatives.</p>
	<p>Waste Electrical and Electronic Equipment Directive (WEEE) 2002/96/EC Waste disposal should comply with local regulations.</p>
	<p>Recommend to refer the User Manual</p>
	<p>Manufacturer information</p>
	<p>JUSHA trademark</p>
	<p>Product serial number</p>

1.3 Safety information

**Warning:**

Read all the important safety information before installing and operating your display.

About the environment

- The equipment should be installed near an easily accessible outlet.
- Place the device on a flat, solid and stable surface that can support the
Weight of at least 3 devices. If you use an unstable cart or stand, the device may fall, causing serious injury to a child or adult, and serious damage to the device.
- Never use the display in the presence of flammable anesthetics mixture with air, oxygen or nitrous oxide.
- Never expose the display to rain or moisture. Never use the display near water - e.g. near a bathtub, washbasin, swimming pool, kitchen sink, laundry tub or in a wet basement.
- Please heed necessary space between the display and the wall for ventilation. Do not cover or block any ventilation openings in the cover of the set.
- Keep small object away from the product. If small object gets into the display, please shut off power supply immediately and contact us for technical support.

About the powering and grounding

- Please use power cord provided with the display.
- Please insert the plug into the socket firmly.
- Don't touch power cord or plug/unplug it when thundering, or it may cause electric shock.
- Please hold the attaching plug when you unplug it. Don't unplug it by pulling power cord, otherwise the power cord may be injured and result in electric shock.
- Don't overload capacity of the circuit, otherwise it may result in fire

or

electric shock.

- Please use the appropriate power supply. Please use the power supply within the voltage range specified in this manual. Otherwise it may cause fire, electric shock or product damage.
- If the device is not used for a long time, disconnect it from the AC inlet to avoid damage by transient over-voltage.
- To fully disengage the power to the device, please disconnect the power cord from the AC inlet.
- Please make sure that this product connected with a qualified computer or other devices, or it is connected to the protective earth.
- Make sure the display is grounded properly.

About the maintains and repairs

- Product failure may cause fire, electric shock or equipment damage. If the product gives off smoke or makes unusual noises, cut off the mains supply as soon as possible and pull out the plug from the socket. Please contact JUSHA for technical support.
- Repairing is limited to trained engineers. Do not try to repair or disassemble the product by yourself. It may cause product damage or personal injury.
- Please don't touch a damaged LCD screen with bared hand. Because the leaking liquid crystal material contains toxic substance. Please contact doctor immediately once it happens.

Some useful recommendations

- For mission critical applications, we strongly recommend that a replacement unit be immediately available.
- Please avoid excessive compression on the LCD screen, which may cause damage to it.
- In order to avoid scratches, don't touch the screen with sharp objects, such as pen or fingernail. Please use a soft cloth to clean the screen.

- The operator should not touch the video interface (such as DVI port, VGA port and etc.), or it may result in potential ESD (Electrostatic Discharge) damage to the display.
- The backlight of LCD has a service life limitation. We strongly suggest that this display is used in the recommended brightness to extend its service life.
- Please turn off the display if not use.
- Waste disposal should comply with local regulations.
- Benefiting from the FPD (Flat Panel Display) technology, this display has clearer image edge compared to a CRT display. It may take time for some new-users to get used to this change.
- If using this display improperly, potential interference to other electronic devices around could be possible. Following methods are proposed to eliminate such interference:
 - ◆ Relocate or reorient the device under interference.
 - ◆ Set up curtain appliance between the display and the device under interference.
 - ◆ Plug the display and the device under interference into different power sockets.

2. Overview

Thank you for choosing JUSHA 5MP professional Display!

- ◆ M550,M550G is a 5MP monochromatic LED display

JUSHA 5MP professional display provides the best visual experience for the diagnostic imaging. It uses the industry-leading LED technology with high luminance, high grayscale, uniform luminance, energy conservation and other advantages. With the advantage of high resolution, high brightness characteristics, and built-in DICOM standard LUT, M550,M550G can be used in a variety of medical imaging diagnostics and comparative analysis, such as: CR, DR, MRI, CT, PACS, etc, and is especially suitable for mammography.



Note:

1. M550G,M550,JUSHA-M550G,JUSHA-M550,M55***,JUSHA-M55***
Where “*” represents the suffix. The suffix indicate different marketing regions. The operation method and specifications is the same as M550G. M550G here describes as an example.
 2. “***” here means 0~9,A~Z or blank.
-

2.1 Features

- **High resolution**

With up to 5 megapixels of resolution, M550G can totally display the details of medical imaging, and meet the medical need for accurate diagnosis.

- **16-bit grayscale display**

M550G is armed with a 16-bit (RGB) image processing chip. It can present up 65536 grayscale, show image more accurately and smooth and guarantee that every detail is perfect.

- **DICOM compliance**

To ensure the most accurate and consistent shadings possible, JUSHA measures rigorously and sets every grayscale on the production line to

produce a monitor compliant with DICOM Part 14.

- **Brightness immediately arise (BIA) technology**

Normally, it takes about 30 minutes for the traditional displays to reach the required luminance and remain stable. JUSHA develops the BIA technology, which shortens the waiting time to 30s with the innovation in luminance driver program.

- **X-ray film view (XFV) function**

Benefiting from the high brightness LED backlight, M550G provides the X-ray film view function that allows the diagnostician to use the display as a film lamp to view the conventional X-ray film.

- **FocusView technology**

According to the real-time coordinates of the mouse cursor position, FocusView technology highlights the corresponding area of the screen. Such technology helps to diagnose the highlighted part more easily.

- **Ambient Brightness Adaption (ABA) technology**

According to the changes of the ambient brightness, this technology can automatically adjust the display backlight to make the display effect more accurate.

- **SmarTouch® patent**

This patent technology can help doctors working in different mode to quickly select the corresponding optimal brightness.

- **Eco-guardian technology**

Eco-guardian technology means the intelligent management of power consumption. It can switch the different energy consumption mode according to the working state of display by infrared sensor technology, which prolongs the service life of the display.

2.2 Packing list

M550G LED Professional Display comes with:

- the display with stand
- this user manual
- a graphic card
- a CD
- an AC power cord
- an external power supply
- a DVI cable
- a DP cable
- a USB cable
- after sales service record (in triplicate)
- a packing list
- a product warranty card
- a product certificate



Note:

1. The packing list is for reference. Please refer to our packing list inside the box
 2. If there is any accessory damage or loss, please contact us.
 3. Please only use the original accessories supplied with the display. JUSHA is not responsible for any technical problems caused by using third-part accessories.
 4. Please keep the original package. If you need to transport the product, use the original package.
-

2.3 Front view and keypad

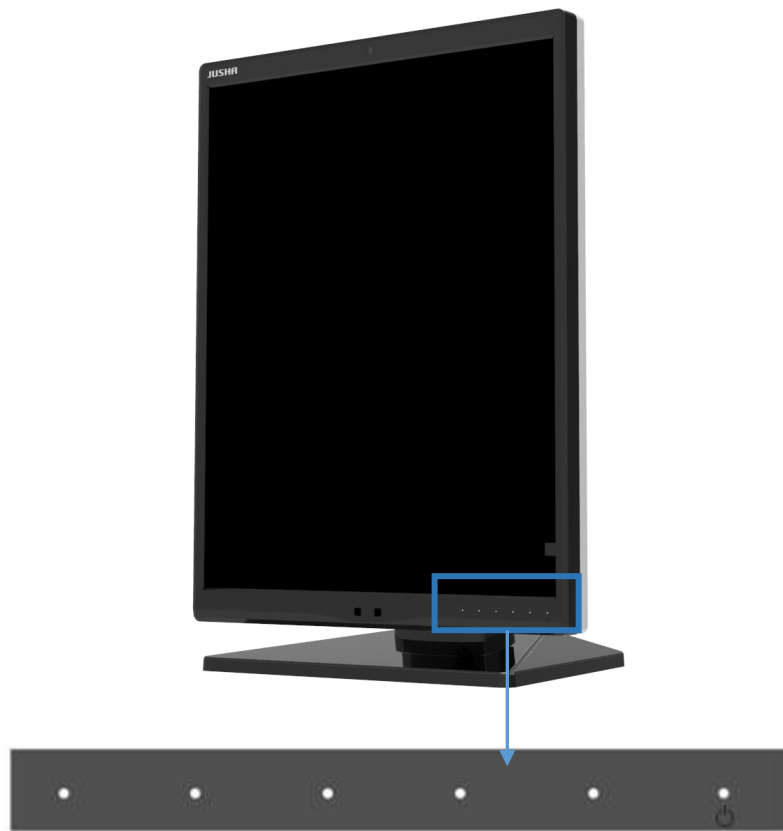











The keys except power key are silkscreen keys. Touch any key except power key to bring up the navigation key icons, as shown below.



Then if touch the key below  , the navigation key icons change, as shown below.



Keypad functions:

Key Define	Key Icon	Function
Power LED		<ol style="list-style-type: none"> 1. Steady white, the display works normally 2. Slow blinking white, no signal. 3. Steady orange , the display works abnormally and bring up an OSD alert 4. Dimmed, the display is off
Power key		To enter sleep mode
Exit key		Exit the OSD (sub) menu
Menu key		Bring up the OSD menu
Down key		To move through the (sub) menus, change values or make selections
Up key		To move through the (sub) menus, change values or make selections
Confirm key		<ol style="list-style-type: none"> 1.To go into a submenu 2.Confirm adjustments and selections
X-ray film view (XFV) key		Turn on/off X-ray film view function
SmarTouch key		Turn on/off SmarTouch
Spotlight key		Turn on/off Spotlight function(FocusView technology)



Note:

The key icons are displayed above the keys, adapted to the functions that it is used for display setting.

2.4 Rear view and connection panel

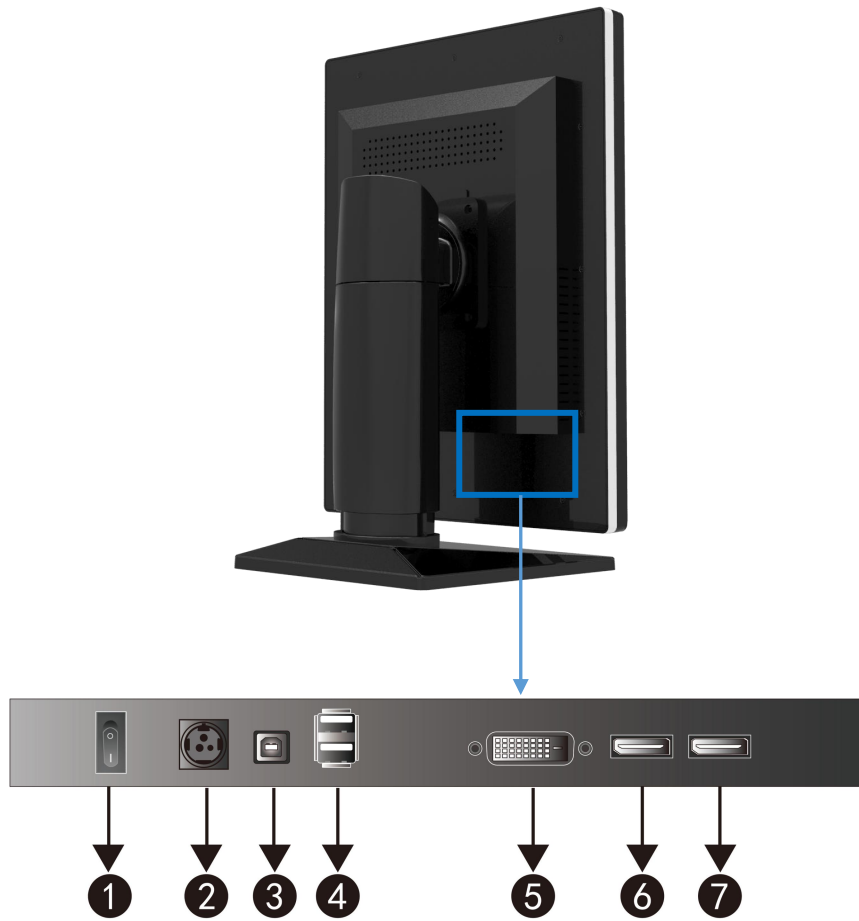

①	Power switch	⑤	DVI-D Dual Link video input
②	Power input	⑥	DP (DisplayPort) video input
③	USB1(USB upstream connector)	⑦	DP(DisplayPort) video output
④	USB2(USB downstream connector)		



Note:

USB2 can be connected to a mouse or keyboard when USB1 is connected to the host.

3. Display installation

3.1 Graphic card installation

**Note:**

Before start to install the graphic card, please make sure the computer motherboard supports the PCI Express graphic card and has an empty PCI Express x1 Slot. Carefully read the manual of the motherboard about how to install an expansion card.

1. Turn off the computer and unplug the power cord from the power outlet before installing the graphic card.
2. Open the computer chassis cover and locate a PCI Express x1 Slot that supports the graphic card. Remove the metal slot cover from the chassis back panel.
3. Align the card with the slot, and press down on the card until it is fully seated in the slot. Make sure the metal contacts on the card are completely inserted into the slot.

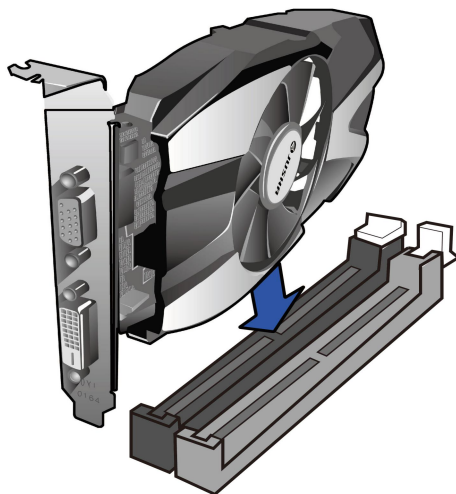

PCI Express x16 Slot



4. Secure the card's metal bracket to the chassis back panel with a screw.
5. If the graphic card needs independent power supply, please connect power supply line to the graphic card.
6. After installation, put the computer chassis back to normal and connect the display to the computer (Please see 3.2 "**Connecting the cables**" section). After that, turn on the computer.

As for the video card driver installation, please refer to the driver installation instructions in CD.

3.2 Connecting the cables

Use the DVI or DP video cables to connect the monitor to the computer host graphic card. The display will automatically complete the selection of video input signal.

1. Through the video cables, put the video interface on the graphics, such as DVI, DP, etc., connect to the corresponding video interface on the display. For DVI connector, please tighten the screws of the connectors.



2. Connect the power cord to the power input interface on the display.



Note:

The display supported video interfaces can be found in 5.1 “**Technical specifications**”.

3. Turn on the power switch. When the power key indicator light is lit up, it means that the display has been powered up.

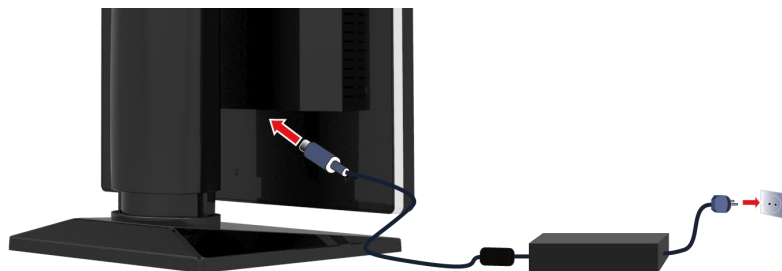

Warning:

Please read the 5.3 “**Safety standard**” section carefully before connecting the power supply. Otherwise, it may cause electric shock or display permanent damage.

3.3 Adjusting the screen position

You can adjust the height and angle of the display screen, in order to get the most comfortable viewing angle.

3.3.1 Adjusting screen height

To move the screen up and down, please hold the screen at both sides and adjust it to an appropriate height.



Warning:

When moving the screen down, don't touch the monitor pillar to avoid hand injury.



3.3.2 Adjusting the tilt and swivel angle

Please hold the screen at both sides and adjust it to a convenient tilt and

swivel angle.



Note:

The allowed tilt angle range for this display is from $0^{\circ} (\pm 2^{\circ})$ to $+ 20^{\circ} (\pm 2^{\circ})$.
The swivel angle range is from $-45^{\circ}(\pm 4^{\circ})$ to $+ 45^{\circ}(\pm 4^{\circ})$.

3.3.3 Rotating screen

1. Please remove all connections of the display at first.
2. Move the screen up to the top height and tilt it to a suitable angle, in order to avoid the impact against table or fingers clipping.
3. When rotating, please hold the left and right sides with both hands. To rotate it from portrait to landscape, rotate it anti-clockwise. To rotate it from portrait to landscape, rotate it clockwise.

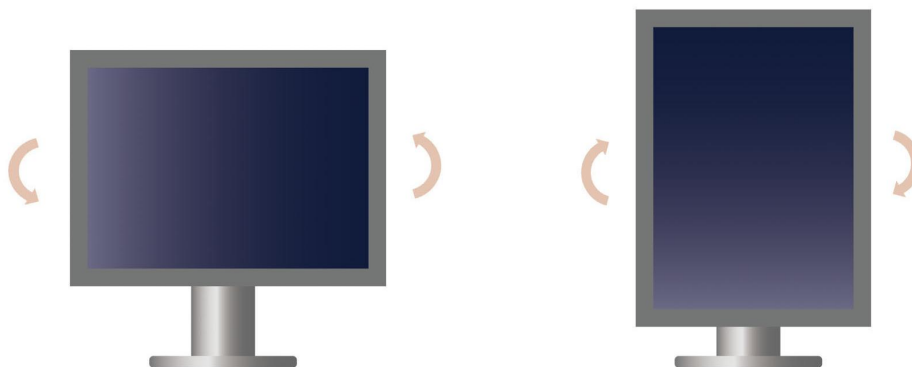

4. In the windows **<Screen Resolution>** control panel, pull down the **<Orientation>** menu. Select **<landscape>** or **<Portrait(flipped)>** according to current display status.

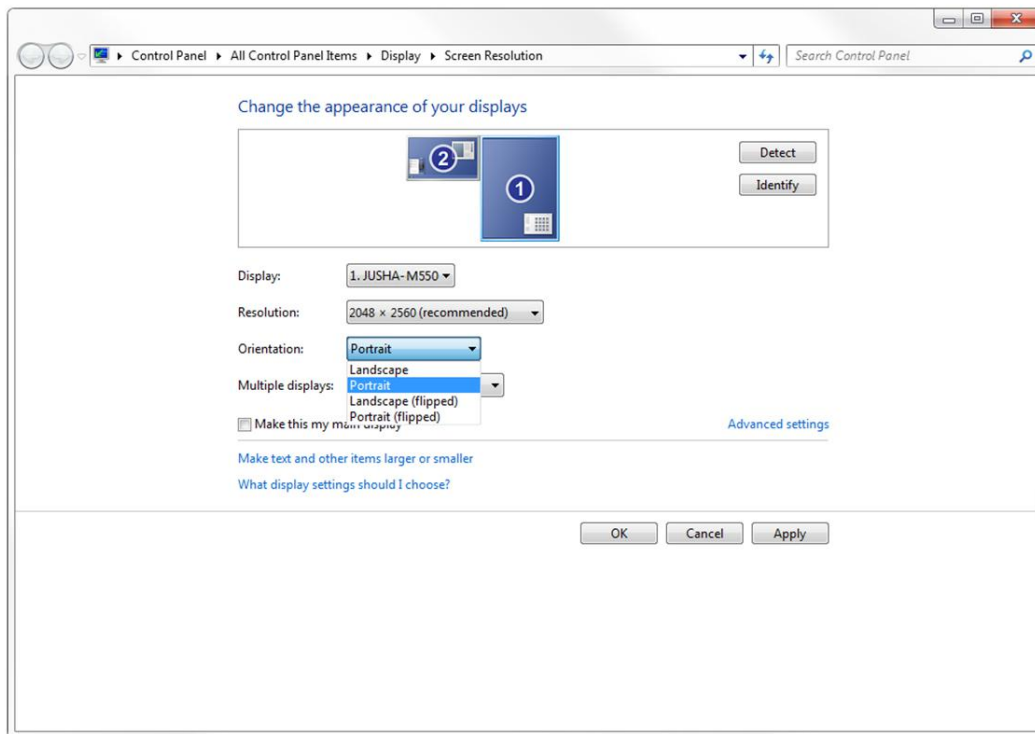

3.4 Installing the display to wall or suspended arm

The panel, standard attached to a stand, is compatible with the VESA 100 mm standard. Thus, it can be installed onto wall or used with an arm that is approved by VESA. But first of all, you need to confirm that the stand of the display will be dismantled before hanging, and the arm can support the weight of the display.



Warning:

Contact a technician for the installation. JUSHA is not responsible for any damage to the product or harm to customers when the installation is done by the customer.

3.5 Multi-display configuration

Windows OS provides the multi-display feature to allow applications to make use of multiple display devices at the same time. This is useful whenever you need to maximize your onscreen workspace. For example, there are two displays used at the same time: one is used to view the medical images for diagnosis, while the other is used to browse the patient medical history.

3.5.1 For Microsoft Windows XP operation system

1. The DVI or DP interface on the graphic card is connected to the corresponding DVI or DP interface on display by using video signal cables (Please see “3.2 connecting the cables” section).
2. Right-click mouse button on the desktop blank place, and then select “**Properties**” in the pop-up menu.
3. Click “**Settings**” to open the display settings windows.
4. Click “**Identify**” to identify multi-display number in Windows XP system. Click “Use the device as the primary monitor” item to setup the primary monitor.
5. Click “**To expand Windows desktop to the monitor**” item to expand Windows desktop to the selected monitor.
6. After the completion of the various Settings, and then identify the number of the screen representing.
7. For example, the monitor in 5MP single screen mode corresponds to the number 1 of the 5MP display in Windows XP. Slide from left to right in “**Screen resolution**” to select the recommended resolution 2560x2048.
8. Finally, to click “**Sure**” to make the all of above options to take effect.

3.5.2 For Microsoft Windows 7 operation system

1. The DVI or DP interface on the graphic card is connected to the display corresponding DVI or DP interface by using video cables. (Please see “3.2 connecting the cables” section).
2. Right-click mouse on the windows desktop blank place, and select the “**Screen resolution**” on the pop-up menu.
3. Windows can automatically detect additional displays, as shown below.

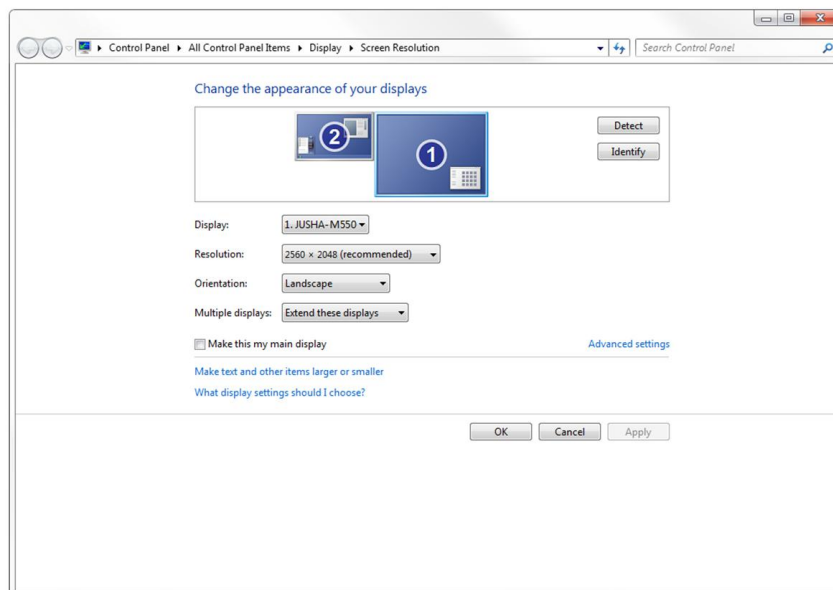

In the “**Screen resolution**” control panel, you can:

- Arrange the logical position of the two displays by dragging the display icons.
- Browse the connected display devices at the “**Display**” pull-down menu.
- Choose different multi-display mode in the “**Multiple displays**” pull-down menu. For example, you can choose “**Extend these displays**” to obtain a larger onscreen workspace.
- Designate which screen is the primary one to display the windows Taskbar and Start menu by selecting the “**Make this my main display**” check box.



Note:

The setup method of multi-display extension function in Windows 8/10 is similar to Windows 7.

4. Display settings



4.1 First time starting up

1. Open a computer connected to your monitor. Make sure that a display and a graphic card and graphic card driver has been installed correctly.
2. Turn on the power switch, and then touch the power key  for approximately 1 second, all the key lights are lit up at the same time. As a result, the power LED becomes steady white and the display will be switched on.

Warning:

The connected power supply also provides a switch that can be used to turn the power completely off. To use the display, please make sure to switch on this power supply. This can be done by pushing the on/off switch on the power supply into the “ | ” position.

4.2 Sleeping

Touch the power key , then bring up a note “Press Power key to turn off Monitor”. If you really need Sleeping to be enabled, please touch the power key .

4.3 OSD overview

User can change display settings by keypad and OSD (On Screen Display) menu to meet the needs of the working environment. Similarly, the user can also view the basic information and the current settings of the display by using OSD menu.

The OSD menu is divided into 3 regions:

- The top of the OSD menu is the status region, showing the signal source and the current video input signal resolution.
- The left-lower region is the main menu.
- The right-lower region is the submenu.
 - ◆ If no item is selected in the main menu, the submenu region shows current display status.
 - ◆ If one item is selected in the main menu, the submenu region shows its detail setting.

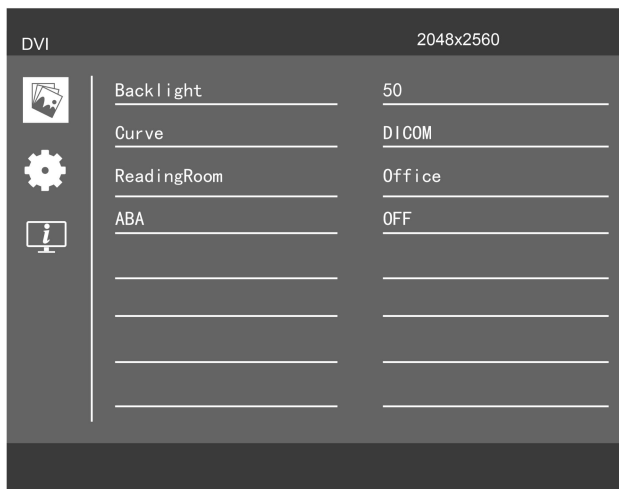



Note:

This menu is just an example, and the content of the menu is variation with different display. Please refer to the actual menu.

The key icons are displayed above the keys, adapted to the function that it is used for OSD menu dependent.

The following table shows the structure and parameters of the OSD menu in English.

Main Menu	Submenu	Parameter Specification	Default Settings
	Backlight	0-100	50
	Curve	DICOM	DICOM
		CT/MRI	
		Gamma2.2	
		Gamma2.4	
		DSA	
		DSI	
	Reading Room	Close	Close
		Auto	
		Diagnostic	
		CT/MR/NM	
		Office	
		Viewing	
		ER	
OR			
ABA	OFF	OFF	
	ON		
	Input Source	DVI	DVI
		DP	
	Spotlight Type	Circle	Circle
		Rectangular	
	Spotlight Size	Small	Middle
		Middle	
		Large	
	PI	OFF	OFF
		ON	
	Key Music	OFF	OFF
		ON	
Language	English	English	
	简体中文		
Factory Reset			No
	Temperature	Real-time Information	Real-time Update
	Backlight Sensor		
	Backlight On time		



Note:

This product menu options and specifications are subject to change without prior notice.

4.4 OSD operation

4.4.1 Open OSD

Bringing up the OSD menu can be done by:



1. In the state of that the display is turned on, touch any key except power key to bring up the navigation key icon.
2. Touch the menu icon corresponding key  to bring up the OSD menu.

As a result, the OSD main menu comes up in the screen. However, if no

Further action is taken within the following 20 seconds, the OSD will disappear.









4.4.2 Exit OSD

There are two ways to exit OSD menu as follows:

1. When OSD cursor is in the submenu region, touch the key  to back to the OSD main menu region. When OSD cursor is in the main menu region, touch the key  to exit OSD menu.
2. If no further action is taken within the following 20 seconds, the OSD menu will disappear automatically.

4.4.3 Change Backlight

The backlight can be adjusted, and the operation is as follows:











1. Touch any key except power key to bring up the navigation key icon.
2. Touch the menu key  to bring up the OSD main menu. By default, the OSD cursor is in the  main menu.
3. Touch the confirm key  to enter the  submenu .
4. Touch the key  /  to move the cursor to the "Backlight" item, and then touch the key  to enter the brightness progress bar item.
5. Touch the key  /  to make the value of the backlight progress bar item to increase or decrease. Set a luminance target value as desired.

**Note:**

LED backlight has a certain lifetime. Recommend to use the brightness of the factory default values to optimize the lifetime of your display.

4.4.4 Change Curve

There are six calibration curves built in the display, and the user can choose any one curve as desired. The operation is as follows:









1. Touch any key except power key to bring up the navigation key icon.
2. Touch the menu key  to bring up the OSD main menu. By default, the OSD cursor is in the  main menu.
3. Touch the confirm key  to enter the  submenu.
4. Touch the key  /  to move the cursor to the "Curve" item, and then touch the key  to enter the calibration curves item.
5. Touch the key  /  to choose any one curve as desired and touch the key  to confirm.

**Note:**

The DICOM curve built in the display is a precise calibration curve by accurately measuring to approach the perfect DICOM curve as good as possible. We suggest user to choose DICOM calibration curve to browse the most of the medical image.

4.4.5 Reading Room

The display has Reading Room function to be chosen as desired. The operation is as follows:

1. Touch any key except power key to bring up the navigation key icon.
2. Touch the menu key  to bring up the OSD main menu. By default, the OSD cursor is in the  main menu.
3. Touch the confirm key  to enter the  submenu.
4. Touch the key  /  to move the cursor to the "Reading Room" item, and then touch the key  to enter the "Reading Room" item.
5. Touch the key  /  to select one Reading Room as desired and

touch the key  to confirm.













Note:

Reading Room can only be enabled on your display when the DICOM display function is selected.

4.4.6 Ambient Brightness Adaptation

The display has Ambient Brightness Adaptation (ABA) function to be chosen as desired. The operation is as follows:

1. Touch any key except power key to bring up the navigation key icon.
2. Touch the menu key  to bring up the OSD main menu. By default, the OSD cursor is in the  main menu.
3. Touch the confirm key  to enter the  submenu.
4. Touch the key  /  to move the cursor to the "ABA" item, and then touch the key  to enter the "ABA" item.
5. Touch the key  /  to choose to turn on or off ABA function and touch the key  to confirm.















Note:

1. The function of the ambient brightness adaptation and the function of the SmarTouch, Spotlight, X-ray film viewing cannot be used at the same time. Before open the function of the ambient brightness adaptation, the function of the SmarTouch, Spotlight, X-ray film viewing will automatically be closed.
2. When open the function of the ambient brightness adaptation, the brightness menu on the OSD menu can't be adjusted.

4.4.7 Change Input Source













The display has different video input source to be chosen as desired. The operation is as follows:

1. Touch any key except power key to bring up the navigation key icon.
2. Touch the menu key  to bring up the OSD main menu. By default, the OSD cursor is in the  main menu.
3. Touch the key  /  to move the cursor to the , then touch the confirm key  to enter the  submenu.
4. Touch the key  /  to move the cursor to the "Input Source"

- item, and then touch the key  to enter the "Input Source" item.
5. Touch the key  /  to choose <DVI> or <DP> as demand and touch the key  to confirm.













4.4.8 Spotlight Type

The display has two different spotlight type to be chosen as desired. The operation is as follows:

1. Touch any key except power key to bring up the navigation key icon.
2. Touch the menu key  to bring up the OSD main menu. By default, the OSD cursor is in the  main menu.
3. Touch the key  /  to move the cursor to the , then touch the confirm key  to enter the  submenu.
4. Touch the key  /  to move the cursor to the "Spotlight Type" item, and then touch the key  to enter the "Spotlight Type" item.
5. Touch the key  /  to select a desired spotlight type and touch the key  to confirm.

4.4.9 Spotlight Size













The display has three different spotlight sizes to be chosen as desired. The operation is as follows:

1. Touch any key except power key to bring up the navigation key icon.
2. Touch the menu key  to bring up the OSD main menu. By default, the OSD cursor is in the  main menu.
3. Touch the key  /  to move the cursor to the , then touch the confirm key  to enter the  submenu.
4. Touch the key  /  to move the cursor to the "Spotlight Size" item, and then touch the key  to enter the "Spotlight Size" item.
5. Touch the key  /  to select a desired spotlight size and touch the key  to confirm.

4.4.10 Presence Induction













The display has Presence Induction (PI) function to be chosen as desired.

The operation is as follows:

1. Touch any key except power key to bring up the navigation key icon.
2. Touch the menu key  to bring up the OSD main menu. By default, the OSD cursor is in the  main menu.
3. Touch the key  /  to move the cursor to the , then touch the confirm key  to enter the  submenu.
4. Touch the key  /  to move the cursor to the "PI" item, and then touch the key  to enter the "PI" item.
5. Touch the key  /  to turn on or off PI function and touch the key  to confirm.









4.4.11 Key Music





The display has a key music to be chosen as desired. The operation is as follows:

1. Touch any key except power key to bring up the navigation key icon.
2. Touch the menu key  to bring up the OSD main menu. By default, the OSD cursor is in the  main menu.
3. Touch the key  /  to move the cursor to the , then touch the confirm key  to enter the  submenu.
4. Touch the key  /  to move the cursor to the "Key Music" item, and then touch the key  to enter the "Key Music" item.
5. Touch the key  /  to turn on or off the key music and touch the key  to confirm.

4.4.12 OSD Language











The display provides two kinds of languages to be chosen from Chinese and English. The operation to choose OSD menu language is as follows:

1. Touch any key except power key to bring up the navigation key icon.
2. Touch the menu key  to bring up the OSD main menu. By default, the OSD cursor is in the  main menu.
3. Touch the key  /  to move the cursor to the  main menu, and then touch the key  to enter the  submenu.
4. Touch the key  /  to move the cursor to the "Language" item,

- and then touch the menu key  to enter the "Language" item.
5. Touch the key  /  to choose Chinese or English language and touch the key  to confirm.





4.4.13 Factory Reset

Before delivery, the display has a default and recommended factory settings. User can reset factory settings this function. The operation to reset factory settings is as follows:

1. Touch any key except power key to bring up the navigation key icon.
2. Touch the menu key  to bring up the OSD main menu. By default, the OSD cursor is in the  main menu.
3. Touch the key  /  to move the cursor to the  main menu, and then touch the key  to enter the  submenu.
4. Touch the key  /  to move the cursor to the "Factory Reset" item, and then touch the menu key  to reset factory settings.

4.4.14 Display Status

By viewing OSD menu, get the current status information about the display, including temperature, backlight sensor status and backlight on time. The operation about the display status is as follows:

1. Touch any key except power key to bring up the navigation key icon.
2. Touch the menu key  to bring up the OSD main menu. By default, the OSD cursor is in the  main menu.
3. Touch the key  /  to move the cursor to the  main menu. At this moment, to view the display status information on the OSD submenu.

4.5 Feature function setting

For the convenience of users, M550G provides shortcuts to quickly call useful special functions.

4.5.1 SmarTouch

Touch any key except power key to bring up the navigation key icon.

Then touch the key  to turn on or off the function of the SmarTouch.



Note:

1. The function of the SmarTouch and Ambient brightness cannot be used at the same time. When open the function of the SmarTouch, the function of the ambient brightness will automatically be closed. Only to close the function of the SmarTouch, the function of the ambient brightness will automatically be opened.
 2. When open the function of the SmarTouch, the brightness menu on the OSD menu can't be adjusted.
-

4.5.2 X-ray film viewing

Touch any key except power key to bring up the navigation key icon.

Then touch the key  to turn on or off the function of the X-ray film viewing.



Note:

1. The function of the X-ray film viewing and the function of the ambient brightness cannot be used at the same time. Once turning on the function of the X-ray film viewing, the function of the ambient brightness will automatically be closed. When turning off the function of the X-ray film viewing, the function of the ambient brightness will automatically be opened.
 2. When open the function of the ambient brightness, the brightness menu on the OSD menu can't be adjusted.
-

4.5.3 Spotlight

Touch any key except power key to bring up the navigation key icon.

Then touch the key  to turn on or off the function of the spotlight function.



Note:

1. Spotlight function requires the independent software to support. Therefore, please refer to the dedicated user guide about installing and using JUSHA CGA software on the documentation CD.
2. The function of the Spotlight and Ambient brightness cannot be used at the same time. When open the function of the Spotlight, the function of the ambient brightness will automatically be closed. Only to close the function of the Spotlight, the function of the ambient brightness will automatically be opened.
3. When open the function of the Spotlight, the brightness menu on the OSD menu can't be adjusted.

5. Important information

5.1 Technical specifications

Input voltage	DC 24V
Power consumption	<55W(Typical)
LCD Panel	21.3 inches, mono -TFT Liquid Crystal Display
Viewing angle	89°H and V @ CR ≥ 10
Resolution	2560*2048
Grayscale tone	65536(16bit)
Active screen size	422.4 mm x 337.9 mm
Sensor	Backlight Sensor、 Ambient Sensor、 Front Sensor、 Temperature Sensor
DICOM calibrated luminance	500cd/m2(default, typical)
Input video interface	DVI-D MAX Resolution 2560*2048
	DPx1 MAX Resolution 2560*2048
Output video interface	DPx1
Net weight with stand	10.1 ± 0.3kg
Net weight w/o stand	6.5 ± 0.3kg
Operating Environment	Temperature: 0°C ~ 35°C Humidity: 20% - 80% (No condensation) Air pressure: 700hPa - 1060hPa
Transportation and storage Environment	Temperature: -20°C ~ 60°C Humidity: 5% - 85%(No condensation) Air pressure: 200hPa ~ 1060hPa
Certification standards	CCC,CE



Note:

The specifications of JUSHA products are subject to change without notice.

5.2 Environmental information

All materials of this product are below the limit requirement in RoHS,

without toxic or hazardous substances.

5.3 Safety standard

Safety standard	This device complies with IEC 60601- 1: 2012 EN 60601-1:2013 GB4943.1-2011
Compliance disclaimer	CCC、CE

5.4 Electromagnetic compatibility

5.4.1 EMC information



Warning: Display requires special precautions regarding EMC and need to be installed, put into service and used according to the following information.

1. Do not use other cables that aren't provided or specified by us. Using other cables may cause the increase of emission or decrease of immunity.
2. With the installation of the device, use only the delivered power supply or a spare part provided by a legal manufacturer. Using another can result in a decrease of the immunity level of the device.
3. Do not put any portable and mobile RF communications equipment close to display. Doing so may affect display.
4. Display should not be used adjacent to or stacked with other equipment. If adjacent or stacked use is necessary, the equipment or system should be observed to verify normal operation in the configuration in which it will be used.
5. Anyone who connects additional equipment to the signal input part or signal output parts, configuring a medical system, are responsible for that the system complies with the requirements of IEC/EN60601-1-2.

Guidance and manufacturer's declaration

Below cables information are provided for EMC reference.

Cable	Max. cable length, Shielded/unshielded		Number	Cable classification
AC Power Line	1.7m	Unshielded	1 Set	AC Power
DVI Cable	1.9m	shielded	1 Set	DC Power
DP Cable	1.9m	shielded	1 Set	DC Power
USB Cable	1.7m	shielded	1 Set	DC Power

Important information regarding Electro Magnetic Compatibility (EMC)

LCD MONITOR needs special precautions regarding EMC and put into service according to the EMC information provided in the user manual; LCD MONITOR conforms to this IEC 60601-1-2:2014 standard for both immunity and emissions. Nevertheless, special precautions need to be observed:

- LCD MEDICAL DISPLAY with no ESSENTIAL PERFORMANCE is intended used in Professional healthcare facility environment.
- WARNING: Portable RF communications equipment (including peripherals such as antenna cables and external antennas) should be used no closer than 30 cm (12 inches) to any part of the LCD MEDICAL DISPLAY, including cables specified by the manufacturer. Otherwise, degradation of the performance of this equipment could result.”
- The use of accessories and cables other than those specified by NANJING JUSHA DISPLAY TECHNOLOGY CO., LTD., with the exception of accessories and cables sold by NANJING JUSHA DISPLAY TECHNOLOGY CO., LTD. of LCD MEDICAL DISPLAY as replacement parts for internal components, may result in increased EMISSIONS or decreased IMMUNITY of the LCD MEDICAL DISPLAY.
- WARNING: Use of this equipment LCD MEDICAL DISPLAY adjacent to or stacked with other equipment should be avoided because it could result in improper operation.”
- When the AC input voltage is interrupted, the LCD MEDICAL DISPLAY will shut down and if the power supply restored, it could be recovered automatically, this degradation could be accepted because it will not lead to unacceptable risks and it will not result in the loss of basic safety or essential performance.

EMI Compliance Table

Table 1 - Emission

Phenomenon	Compliance	Electromagnetic environment
RF emissions	CISPR 11 Group 1, Class B	Professional healthcare facility environment
Harmonic distortion	IEC 61000-3-2 Class A	Professional healthcare facility environment
Voltage fluctuations and flicker	IEC 61000-3-3 Compliance	Professional healthcare facility environment

EMS Compliance Table

Table 2 - Enclosure Port

Phenomenon	Basic EMC standard	Immunity test levels
		Professional healthcare facility environment
Electrostatic Discharge	IEC 61000-4-2	±8 kV contact ±2kV, ±4kV, ±8kV, ±15kV air
Radiated RF EM field	IEC 61000-4-3	3V/m 80MHz-2.7GHz 80% AM at 1kHz
Proximity fields from RF wireless communications equipment	IEC 61000-4-3	Refer to table 3
Rated power frequency magnetic fields	IEC 61000-4-8	30A/m 50Hz or 60Hz

Table 3 – Proximity fields from RF wireless communications equipment

Test frequency (MHz)	Band (MHz)	Immunity test levels
		Professional healthcare facility environment
385	380-390	Pulse modulation 18Hz, 27V/m
450	430-470	FM, ±5kHz deviation, 1kHz sine, 28V/m
710	704-787	Pulse modulation 217Hz, 9V/m
745		
780		
810	800-960	Pulse modulation 18Hz, 28V/m
870		
930		
1720	1700-1990	Pulse modulation 217Hz, 28V/m
1845		
1970		

Important information

2450	2400-2570	Pulse modulation 217Hz, 28V/m
5240	5100-5800	Pulse modulation 217Hz, 9V/m
5500		
5785		

Table 4 – Input a.c. power Port

Phenomenon	Basic standard	EMC	Immunity test levels		
			Professional environment	healthcare	facility
Electrical fast transients/burst	IEC 61000-4-4		±2 kV 100kHz repetition frequency		
Surges Line-to-line	IEC 61000-4-5		±0.5 kV, ±1 kV		
Surges Line-to-ground	IEC 61000-4-5		±0.5 kV, ±1 kV, ±2 kV		
Conducted disturbances induced by RF fields	IEC 61000-4-6		3V, 0.15MHz-80MHz 6V in ISM bands between 0.15MHz and 80MHz 80%AM at 1kHz		
Voltage dips	IEC 61000-4-11		0% UT; 0.5 cycle At 0°, 45°, 90°, 135°, 180°, 225°, 270° and 315°		
			0% UT; 1 cycle and 70% UT; 25/30 cycles Single phase: at 0°		
Voltage interruptions	IEC 61000-4-11		0% UT; 250/300 cycles		

Table 5 – Signal input/output parts Port

Phenomenon	Basic EMC standard	Immunity test levels		
		Professional healthcare facility environment		
Conducted disturbances induced by RF fields	IEC 61000-4-6	3V, 0.15MHz-80MHz 6V in ISM bands between 0.15MHz and 80MHz 80%AM at 1kHz		

5.4.2 EMI information

EMI Voltage/ Radiated interference	IEC 60601-1-2:2014 EN 60601-1-2:2015 GB/T9254-2008 GB17625.1-2012
---------------------------------------	--

6. Maintenance

1. Avoid screen over-heat

Please use the display in the recommended environment, including appropriate temperature, humidity and air pressure. Turn off the display or lower its luminance if not use, or it may cause over-heat damage. In addition, if the screen displays the same image for a long time, it may over-heat and cause damage to some pixels.

2. Maintain the proper humidity

The display can work properly at the humidity between 20% and 85%. When humidity is higher than 85%, the condensation may occur inside the display. It makes the display components easy to rust, corroded, or even short-circuit. Therefore, LCD display must be moisture proof. If the display is not used for a long time, user should power on the display once a month at least.

If there is condensation in the screen surface, use a soft cloth to wipe gently before turn on the power. If the moisture has got into the screen, put the screen to a warm (no higher than 60°C) and dry environment to evaporate the moisture. Power a humid LCD will cause a permanent damage.

3. Clean the display properly

It is recommended to clean the display regularly to maintain appearance and extend product service life.

To clean the screen:

- 1) Wipe the screen with a clean, soft, lint-free cloth.
- 2) For further cleaning, apply a small amount of non-ammonia, non-alcohol based cleanser onto the cloth and wipe the screen.



Warning:



1. Make sure the display is powered off before cleaning.
 2. Never spray or pour any liquid directly onto the surface of the screen or case.
-

Some chemical cleanser may damage the screen and case of the display. We recommend you to use non-ammonia and non-alcohol based cleanser. We are not liable for damage resulting from ammonia or alcohol based cleanser.

4. Avoid shock and vibration

The LCD screen is quite fragile, so avoid strong shock and vibration. Falling to the ground or other strong shocks will cause damage to the LCD screen and the electrical components. Besides, please avoid any heavy pressure on the LCD screen surface.

5. Do not disassemble the display

Never try to disassemble the display or remove/change its LCD panel. Unauthorized repair and refit will result in temporary or permanent display failure.

Warning:



1. Please do not touch the metal part of power plug to avoid electric shock.
 2. Please keep the power socket away from water.
 3. Please do not drop the LCD Monitor to avoid hurt yourself.
-

7. Cleaning and Disinfection

7.1 Cleaning

It is recommended to clean the monitor regularly to maintain appearance and prolong product cycle life.

- Make sure the monitor is turned off.
- Never spray or pour any liquid directly onto the screen or case.



To clean the screen:

1. Wipe the screen with a clean, soft, lint-free cloth. This removes dust and other particles.
2. If still not clean, apply a small amount of non-ammonia, non-alcohol based glass cleaner onto a clean, soft, lint-free cloth, and wipe the screen.

Disclaimer

JUSHA does not recommend the use of any ammonia or alcohol-based cleaners on the monitor screen or case. Some chemical cleaners have been reported to damage the screen and/or case of the monitor. JUSHA will not be liable for damage resulting from use of any ammonia or alcohol based cleaners

7.2 Disinfection

It is recommended to disinfection the monitor using 75% alcohol regularly to disinfection the LCD Monitor.

1. Make sure the monitor is turned off.
2. Wipe the screen with a clean, soft, lint-free cloth.



Attention: Never spray or pour alcohol directly onto the screen or case.

8. Malfunction analysis

Note:

Please contact us if failed to resolve problem after reading the recommended solutions followed.

To solve the problem, please contact Nanjing Jusha display technology co., Ltd after-sales service or read the manual to find proper solutions. If you use the recommend below solution still can't solve the problem, please contact Nanjing Jusha display technology co., Ltd.

Problems	Probable solutions
The monitor does not respond	Check that the monitor's Power Switch is on. You turn on the system. Turn off the power and check the monitor's power cord and signal cable for proper connection.
Out of Range display	Check to see if the resolution or vertical frequency of your computer is higher than that of the LCD monitor. Reconfigure the resolution of your computer to make it less than or equal to 2560 x2048. 2560 x 2048 is optimal. See Appendix A for more information on resolution.
Screen too bright or dark	Modify <Backlight> (There if life cycle limit for backlight of monitor. When it becomes dark or vibrant, please contact us.)
Appear ghost	Please confirm in long time display the same image, whether to use screen savers or timer. Ghost is caused by the liquid crystal monitor itself characteristic, should avoid long time display the same image.
Leave traces on the screen to pressure.	Keep the screen is completely white can alleviate this problem.
Restart the computer graphics installed after found no new hardware tips	Graphic card is not inserted or PCI slot has a problem, change slot to install
Snowflake on screen	1. Connection problem of power wire or signal

	<p>wire</p> <p>2. Main board static electricity or dust affection the connection of graphic card.</p>
No figure after displaying well for a while	<p>1. Connection problem of power wire or signal wire</p> <p>2. Main board static electricity or dust affection the connection of graphic card.</p>

9. Declarations

9.1 Legal notice

The auxiliary equipment that is connected with JUSHA display should

meet the corresponding IEC Standard (data processing equipment should meet IEC 60950-1 Standard and armamentariums should meet IEC60601-1 Standard). In addition, all configurations should meet IEC 60601-1-1 Standard. Before a configuration is connected to signal output or input interface for processing system configuration, technician should make sure that the system meets IEC 60601-1-1 Standard.

Staffs that are responsible for connecting the display with system should make sure that installed devices meet IEC 60601-1-1 Standard. If there is any question, please contact with JUSHA Engineering Technology Service Department or local marketing representatives.

JUSHA markets its products through armamentarium manufacturers, distributors and franchisers. Therefore, please consult your seller whether he/she provides relevant maintenance service.

JUSHA will neither take any responsibility nor authorize anyone to take any responsibility for product distribution and its use. Please read carefully the related documents, operation instruction and labels on package before you apply the product so that you can use and maintain the product properly.

Please note that its performance will be affected by system configuration, software, application program and client's data and client's operating control. Though JUSHA product is compatible with many systems, client's specific function might be come true differently. Whether the product is suitable for specific purpose or application program it depends on clients, therefore, JUSHA should not guarantee for it.

JUSHA expressly disclaims all warranties of any kind, whether statutory, express or implied, including, but not limited to, implied warranties of merchantability, fitness for particular purpose and non-infringement. JUSHA hereby explicitly rejects all warranties and state of any kind, any property or extent whether statutory, express or it leads to any laws ,rules, commercial practice, conventions or trade disputes etc.

In no event shall JUSHA and its suppliers/franchisers be liable for any special, incidental, punitive, indirect or consequential damages (including, but not limited to, delay deliver, non-delivery, fault items, product design or production manufacture, being unable to use the product and service, loss of business or profits or other reasons, and any responsibility caused by buy or sell, lease, install or use related products,

these terms and conditions and related articles of agreement.

The limits in this article and/or exclusions are not necessary suitable for some inadmissible exclusion clause, warranties or limited judicial districts. The maximum extent is permitted by applicable law in named jurisdiction under the circumstance.

JUSHA keeps patents, copyright and its exclusive right and all information in this manual including JUSHA all designs and related materials. Anyone cannot plagiarize JUSHA design or copy its product to sell or use without the company's explicit authority.

9.2 After sale service declaration

The after-sale warranty is three years from the date of purchase, only if the product has been used with the recommended brightness. We are

responsible for the quality problems caused by non-artificial factors and the maintenances are free of charge.

Quality assurance is only for the product that Nanjing Jusha Display Technology Co., Ltd provides. Any other third-party equipment problems are beyond the scope of this quality assurance.



Note:

The user must contact and get permission from JUSHA before sending back the product for repairs.

To avoid the damage and/or loss during transit, the user must deliver the product in its original package or other adequate package with an equal degree of protection to the local distributor. Meanwhile, user must present proof of the product purchase date.

The user is not allowed to repair the display from anywhere except the authorized after-service spots. The original serial number should not be modified or removed. Don't derogate from requirements of this manual, otherwise it may result in quality assurance failure.

This product provides limited responsibility for quality assurance. JUSHA isn't responsible for malfunction caused directly/indirectly /accidentally by users themselves. Users should pay attention to the settings of the operation system and other applications. Above factors will affect the product performance.

Manufacture will provide circuit diagrams, component part lists, descriptions, calibration instructions to assist to SERVICE PERSONEL in parts repair.

9.3 Proprietary rights

Nanjing Jusha Display Technology Co., Ltd keeps the copyright of this manual and other related ownership. It is not allowed to copy, use or sell this manual without authorization of Nanjing Jusha Display Technology Co., Ltd.

10. Contact information

Nanjing Jusha Display Technology Co., Ltd.

Address: 8A, Block 1, Nanjing International Service Outsourcing Mansion,
No.301 Hanzhongmen Street, Nanjing City, Jiangsu Province, 210036
China

Tel: 0086-25-83305050

Fax: 0086-25-58783273

Free Hotline: 400-820-0556 800-820-0556

Web: en.jusha.com.cn